

Café IIITM

Café IVTM

Monetary Unit Setup Guide

www.nationalvendors.com

6800058

February, 2000

I. Price Display and Maintenance Keypad

The maintenance keypad (Figure 1) is located on the inside of the monetary cabinet, while the price display (Figure 2) is viewed from the outside. When the machine is in the ready mode, the price display shows the money received.

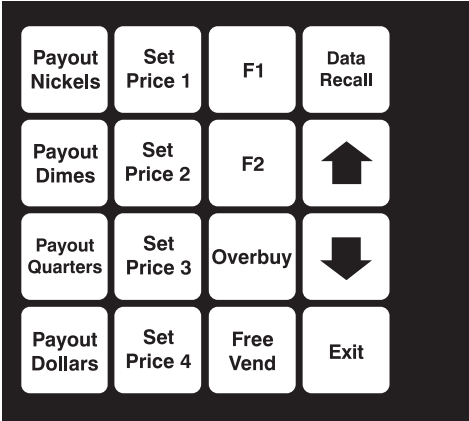

Figure 1.

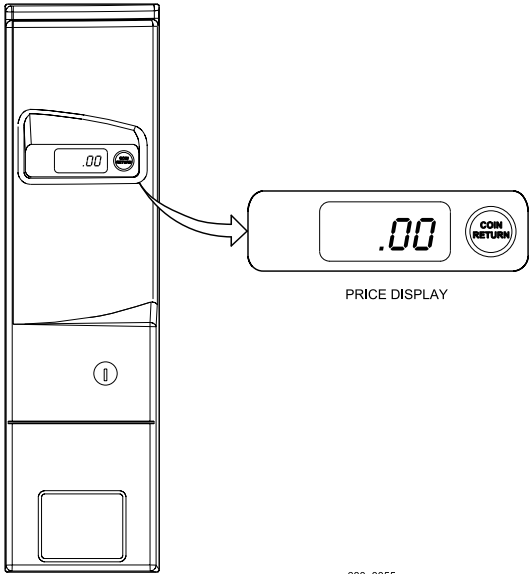
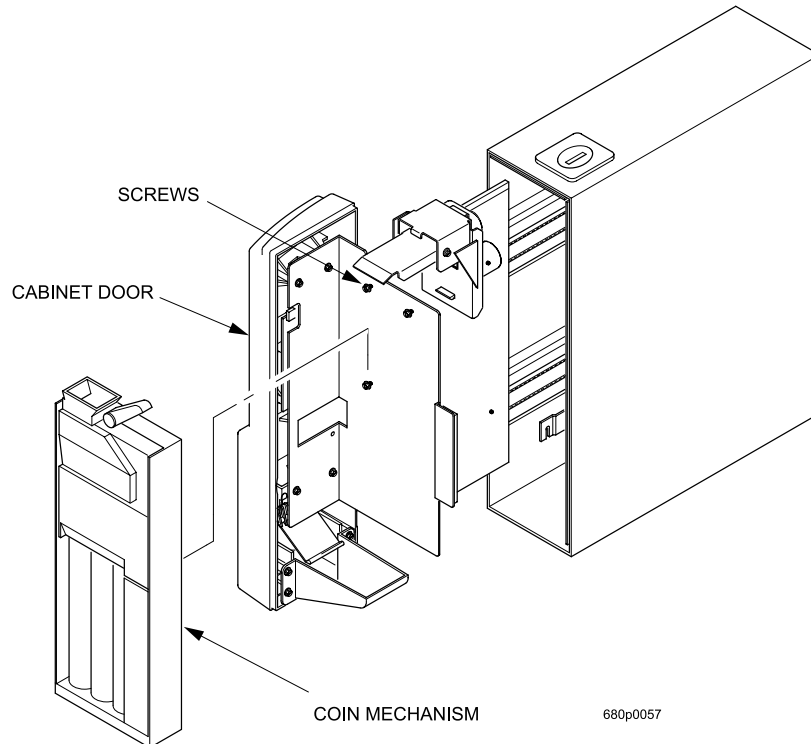

Figure 2.

II. Setup and Adjustment

1. Unlock the monetary cabinet door. Pull the monetary cabinet door forward to expose the monetary keypad. If a coin mechanism was not ordered with this option, install one now. ***Only an MDB type coin mechanism will work with this machine.***



- a. Loosen the three mounting screws on the plate but do not remove them. Remove any parts on the coin mechanism necessary to gain access to the mounting screw holes. Align the back of the coin mech with the screws and slide it down. Tighten these screws to insure proper coin return operation. Connect the coin mechanism to the MDB harness inside the monetary cabinet.

Monetary Unit Setup Guide

Café III Café IV

2. Coin Return Lever Adjustment. The powered coin return lever may need to be adjusted to properly actuate the scavenger lever on the coin mechanism of choice.

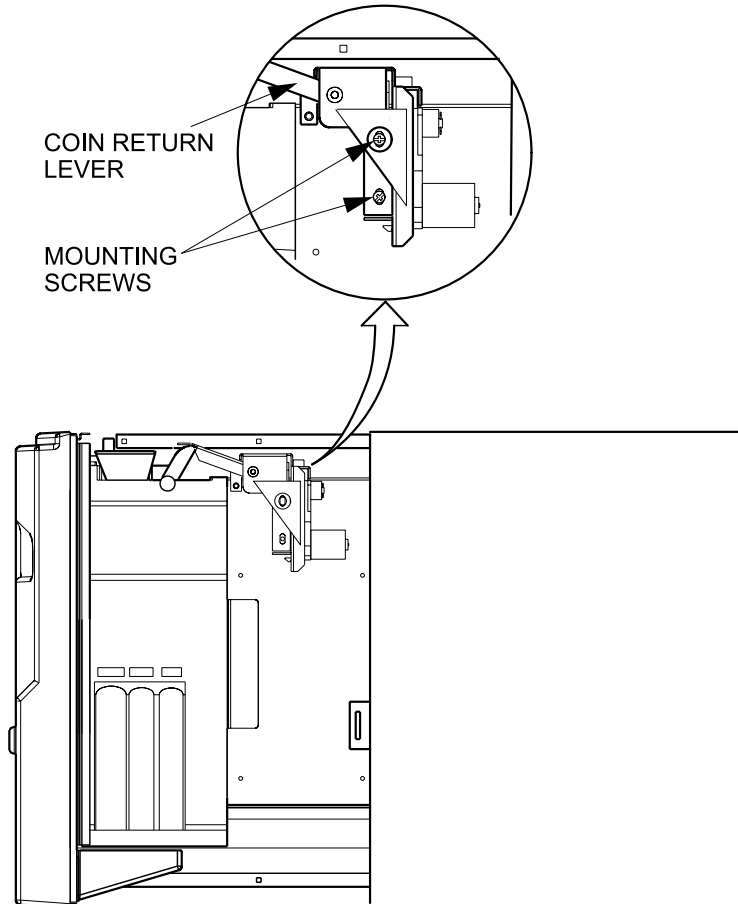





680p0056

- a. Loosen the mounting screws and move the coin return lever up or down as necessary.
 - b. Tighten the mounting screws.
 - c. Test by inserting coins to establish credit, then press the coin return on the front display.
3. Filling coin tubes.
 - a. Insert at least ten of each coin through the slots at the top of each tube.

III. Programming and Maintenance

1. Set prices:

- a. To set the price for selection 1, press . The display shows the default value of **.00**.
- b. Press  or  to adjust the price up or down in **.05** increments. The allowable price range is between **.00** and **2.55**.
- c. Press  to return to the default display.
- d. Repeat steps a through c until all prices are set.

NOTE

After a memory initialization (see the Café III/Café IV Setup Guide), all prices will be set to \$99.00. In addition, a price error (**E.Prc**) and **NonE rdy** error will be displayed on the machine's service display. Setting prices again will clear the

errors. Pressing  while setting prices will set the price to \$0.00.

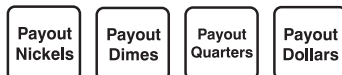

2. Payout coins:

- a. Press one of the following keys to pay coins:



- b. One of the appropriate coins will be paid out. Hold down a key to continue paying out coins.

3. Data recall:



 es una llave doble que hace la misma función como la  llave on the machine's maintenance keypad.

Monetary Unit Setup Guide



Café_{III} Café_{IV}

4. Overbuy:

This option allows a customer to make a drink when there is insufficient change. Note that the customer may be short changed.

- a. Press . The display shows **o. On** or **o. OFF**.
- b. Press  to change from **ON** to **OFF** and back again.
- c. When finished, press  to return to the **.00** display.

5. Free Vend Option: Setting this option to **ON** will allow a drink with no money.

- a. Press . The display will show **F.OFF** or **F.ON**. Press  again to change the setting.

6. Credit Display Operation

- a. As coins are dropped through the coin slot, the credit is accumulated on this display. If a selection is made with a higher price than the credit shown, the price of that selection will be momentarily displayed.
- b. At this point, press the **Coin Return** button or insert more coins until the proper credit is accumulated.